

70w solar street light---Single Lamp



Suitable for: Kenya, Mauritius, Mauritania, Morocco, Philippines, Qatar, Kuwait, Madagascar, etc....

Main Parts	Specification
1) Poly Solar panel	300W
2) LED light	70W/24V
3) Lead-acid battery	80AH/12V*2
4) Controller	20A/24V
5) Pole & lamp arm & bracket of solar panel & battery box, underground fittings, wires and nuts	10.0 m

Special Notes and Instructions

Minimum order quantity: 1sets

Delivery time: within 15 working days after received the deposit.

Working time: 11hours/day, can keep 0 rainy days



Macsun Solar Controller 6 Min Installation Mobile App Control system

Solar LED Street Lamp-70W

	MODEL	MS-SL70
	LED power	70W
	Working Voltage	DC12/24 V
	Source Efficiency	>0.9
	Power Factor	>0.95
	LED Luminous Efficiency	80lm/W
	Lamp Efficiency	>90%
	Ra-color Rendering Index	Ra>65
	CCT-correlated Color Temperature	4000K~6000K
	Working Temperature	-40℃~45℃
	Protection Grade	IP65
	Lifespan	>50000H
	Weight	6.32kg
	Dimension	565x307x70mm

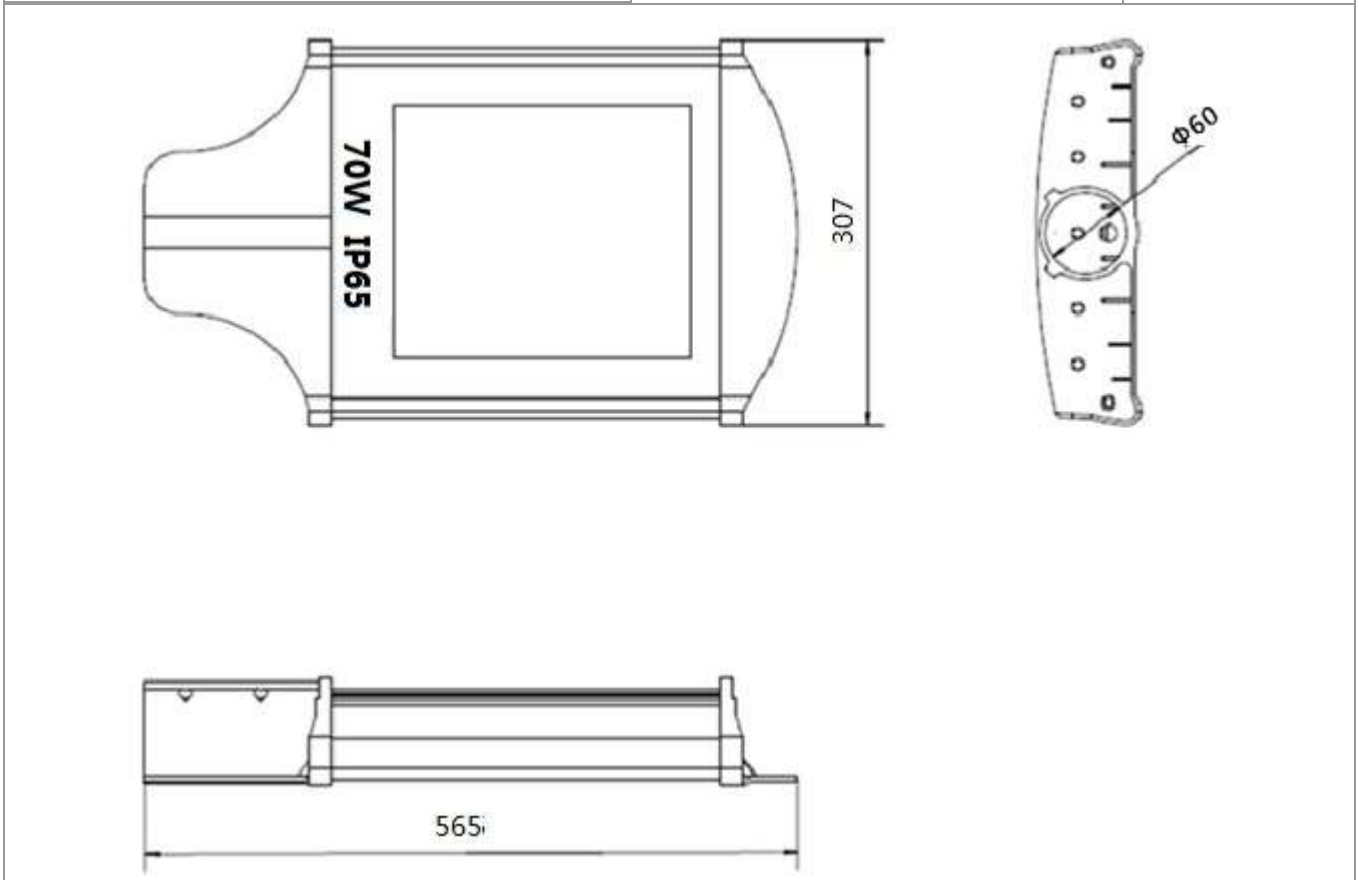

Another 70W LED Lamp Optional:

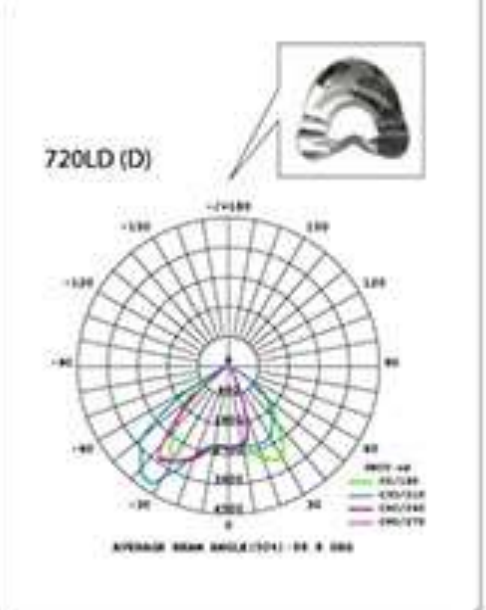
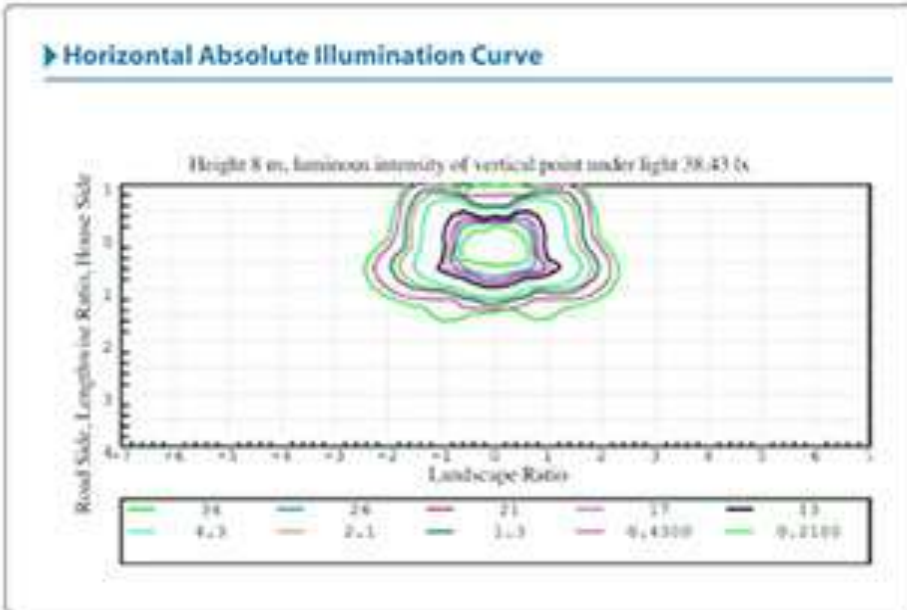
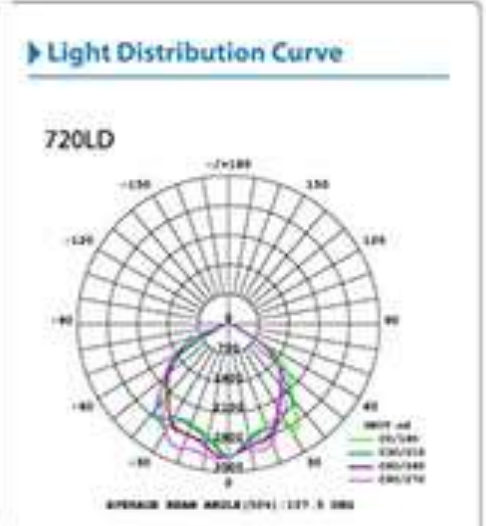
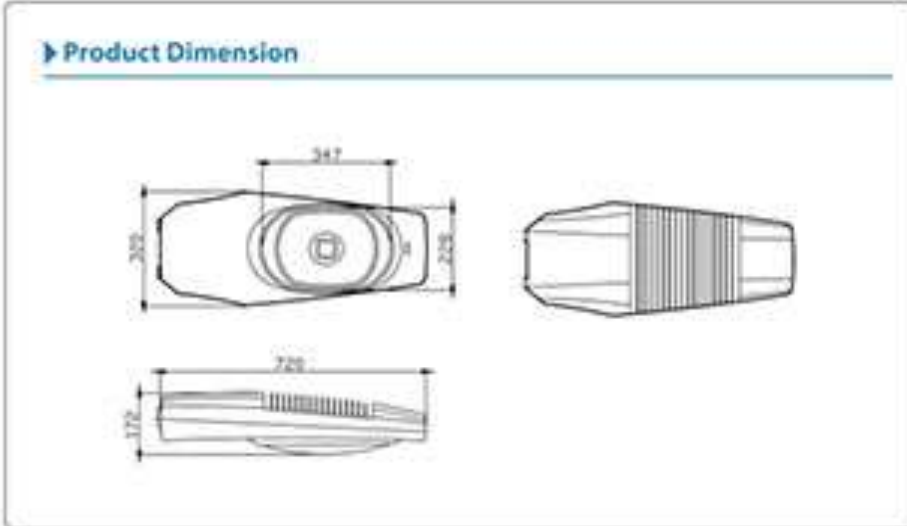

Absolute illumination curve of horizontal plane

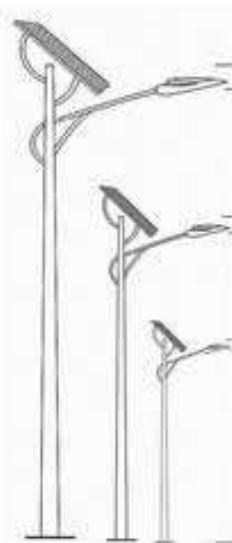
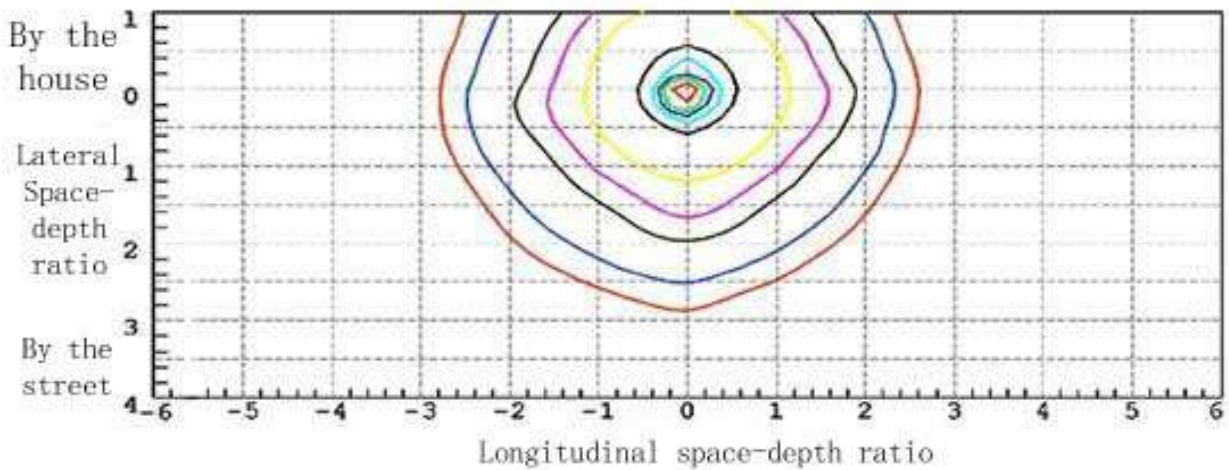

8m	0.391
7.5m	0.444
7m	0.510
6.5m	0.552
6m	0.694
5.5m	0.826
5m	1.000
4.5m	1.235
4m	1.563
3.5m	2.041
3m	2.778
2.5m	4.000
Installation height	Correction factor

19.24	
14.71	
12.45	
9.73	
7.24	
2.38	
1.24	
0.72	
0.24	
0.12	
Illumination color lines	Illumination

Illumination to vertical point under the light 24.05lx

- ⊗ If the installation height is different from the calculated height, please use the correction factor table to calculate the illumination.